



U.S. Department  
of Transportation

**National Highway  
Traffic Safety  
Administration**

400 Seventh Street, S.W.  
Washington, D.C. 20590

Dear Crash Data Researchers/Users:

Thank you for choosing crash data from the National Highway Traffic Safety Administration (NHTSA) for your research or other use. The information contained in this motor vehicle crash report is collected, maintained and distributed in accordance with Public Law 89-564. In accordance with this Public Law, NHTSA is required not to release any case information until completion of quality control procedures. These procedures include a review of the case material to extract all names, licenses and registration numbers, non-coded interview material, non-research related researcher comments in the margins, non-factual data, and the production number portion of the vehicle identification number (VIN).

If you requested NHTSA to query its database files in order to identify a specific crash, then that query was made using non-personal descriptors you provided for use in our search. This motor vehicle crash may have been identified from a data search and matches the general, non-personal descriptors you provided, but we cannot confirm that this is the specific crash report you requested.

If you have any questions with regard to the above procedures, please contact the Field Operations Branch, Crash Investigation Division, National Center for Statistics and Analysis at 202-366-4820. Again, please be advised that we cannot confirm that this is the case that you have specifically requested nor can we certify the information to be correct.

\*\*\* \*\*



AUTO SAFETY HOTLINE  
(800) 424-9393  
Wash. D.C. Area 366-0123

**PEDESTRIAN CASE SUMMARY**

NATIONAL ACCIDENT SAMPLING SYSTEM  
PEDESTRIAN CRASH DATA STUDY

PSU 40 CASE NO. 609P TYPE OF ACCIDENT CAR/PEDESTRIAN CROSSING ROAD STRAIGHT

**A. DESCRIPTION OF THE ACCIDENT SEQUENCE AND ACCIDENT PECULIARITIES**

(Provide a summary of the accident sequence as well as any particular event of the accident that is noteworthy. Pedestrian injury mechanism and vehicle interaction is the focus, not pedestrian or driver culpability. Do not include any personal identifiers.) VEHICLE #1 TRAVELLING EAST MAKING A LEFT TURN, HAD GLARE FROM BRIGHT SUN IN HER EYES, DID NOT SEE PEDESTRIANS AND STRUCK THEM WITH THE FRONT OF VEHICLE.

**B. PEDESTRIAN PROFILE**

Pedestrian No.	Age	Sex	Treatment/Mortality	Most Severe Injury (TO BE COMPLETED BY ZONE CENTER)			
				Body Region	Ana. Struc.	AIS	Injury Source
01	4	1	4	Face	Eye	1	Front Hood Edge

**Body Region**

- Head
- Face
- Throat
- Chest
- Abdomen/Pelvis
- Spine
- Upper Extremity
- Lower Extremity
- External

**Type of Anatomic Structure**

- Whole Area
- Vessels
- Nerves
- Organs
- Skeletal
- Head-LOC
- Skin-Burn
- Skin-Other

**Abbreviated Injury Scale**

- (1) Minor injury
- (2) Moderate injury
- (3) Serious injury
- (4) Severe injury
- (5) Critical injury
- (6) Maximum (untreatable)
- (7) Injured, unknown severity

**C. VEHICLE PROFILE**

Vehicle No.	Class of Vehicle	Year/Make/Model	Most Severe Damage Based on Vehicle Inspection	
			Damage Plane	Damage Description
01	COMPACT	96 SATURN	FRONT	MINOR

**DO NOT SANITIZE THIS FORM**

# ACCIDENT COLLISION DIAGRAM

NATIONAL ACCIDENT SAMPLING SYSTEM  
CRASHWORTHINESS DATA SYSTEM

PSU No. 40

Case Number—Stratum

609 P  
6 AT P

Indicate  
North

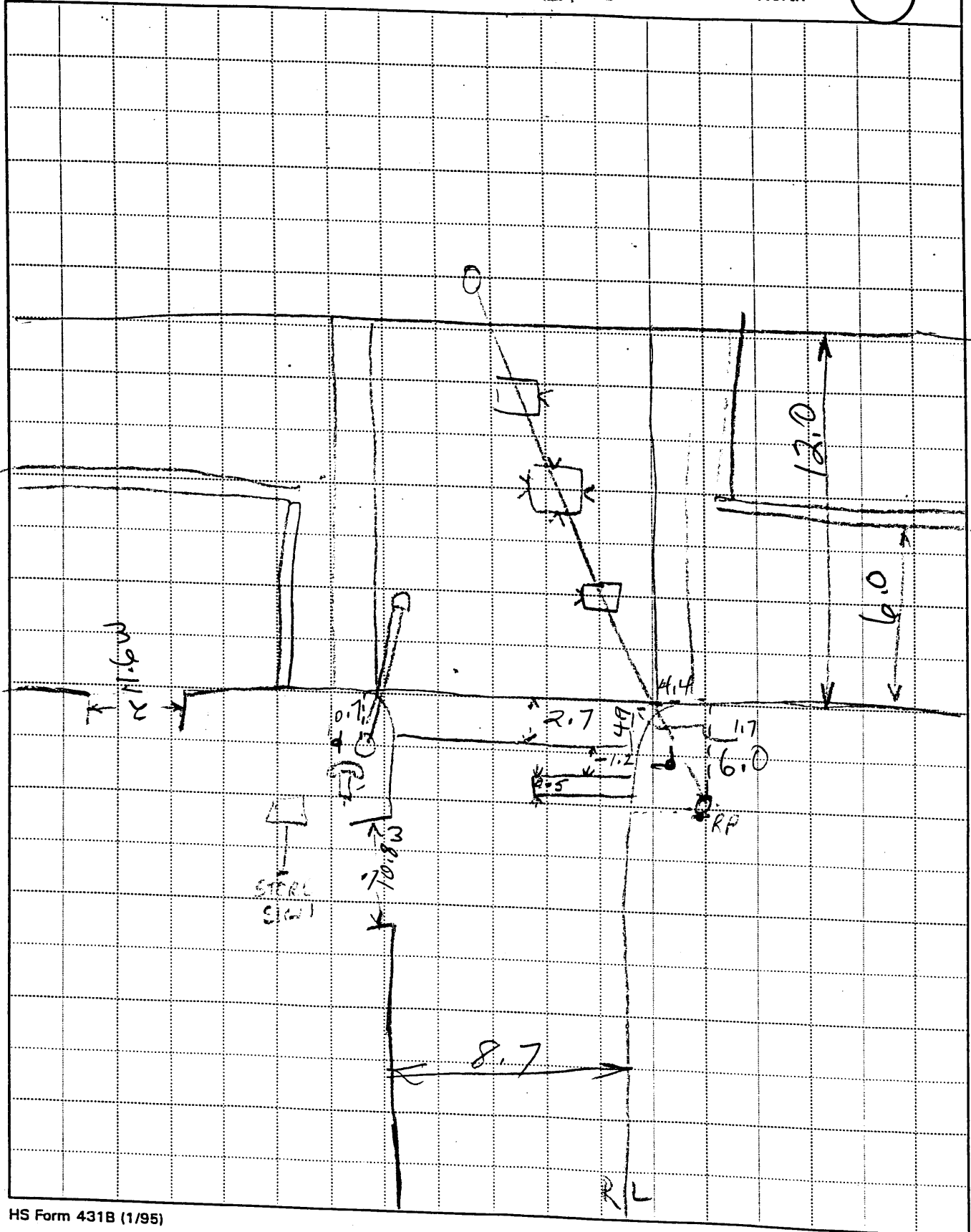
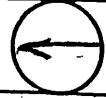

HS Form 431B (1/95)

Scale: 1 centimeter = \_\_\_\_\_ meters

*Dome*

*99*

BEST AVAILABLE

# ACCIDENT COLLISION DIAGRAM

NATIONAL ACCIDENT SAMPLING SYSTEM  
CRASHWORTHINESS DATA SYSTEM

PSU No. 40

Case Number—Stratum 609 P  
A T

Indicate  
North

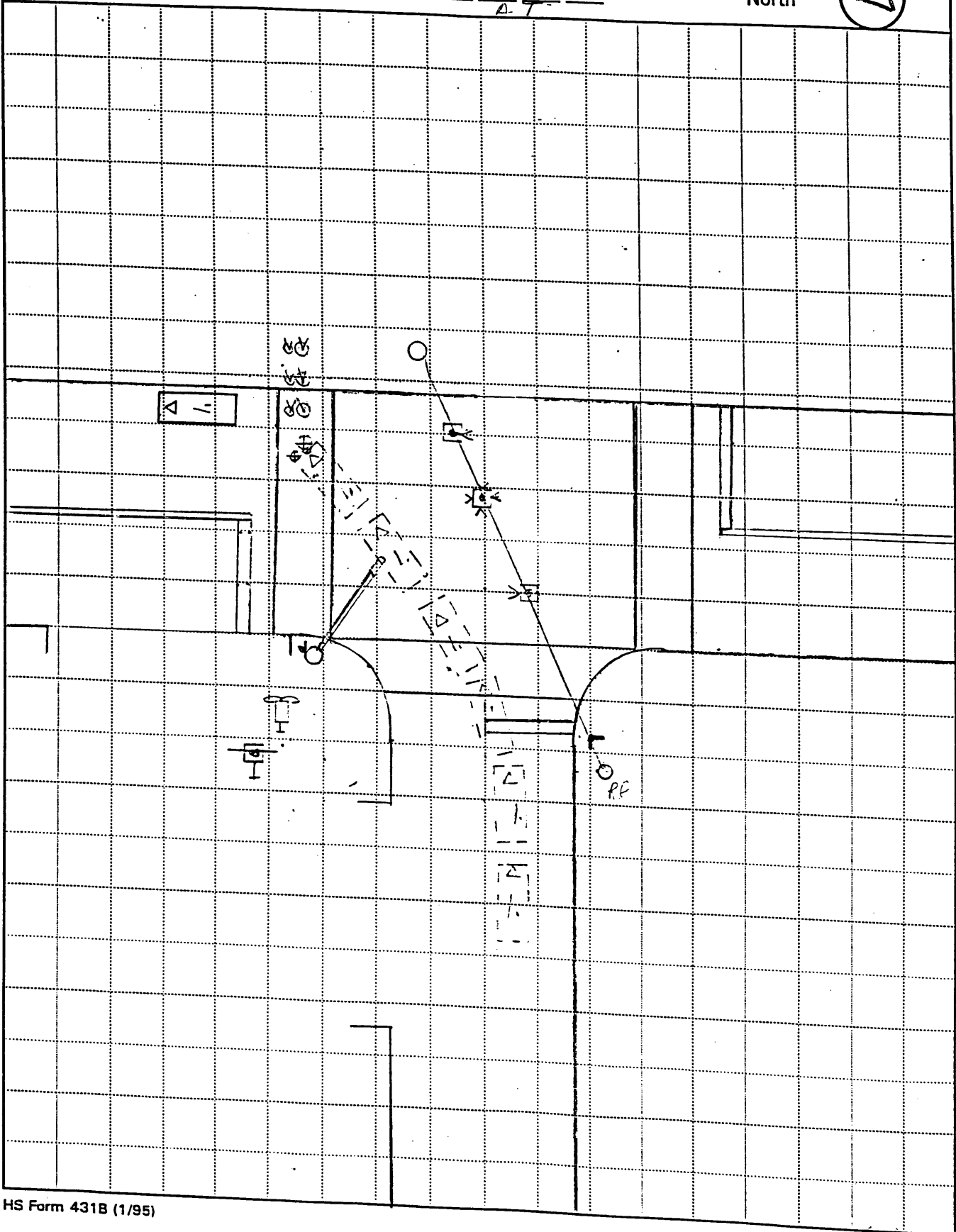
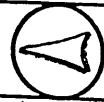



# PEDESTRIAN ACCIDENT COLLISION MEASUREMENT TABLE

Primary Sampling Unit Number 40

Case Number-Stratum 6 09 P  
AT

PEDESTRIAN ACCIDENT COLLISION DATA COLLECTION		SCALED DIAGRAM
* document reference point and reference line relative to physical features	Surface Type <u>ASPHALT</u>	* north arrow placed on diagram
* documentation of all accident induced physical evidence including (if applicable):  a) vehicle skid marks  b) pedestrian contacts with ground or object  c) vehicle/pedestrian point of impact (POI)  d) location of pedestrian separation point from vehicle  f) final resting points (FRP) for pedestrian and vehicle	Surface Condition <u>DRY</u>	* grade measurements for all applicable roadways
	Coefficient of Friction _____	* scaled representations of the physical plant including:  a) all road/roadway delineation (e.g., crosswalks, curb/edge lines, lane markings, medians, pavement markings, parked vehicles, poles, signs, etc.)  b) all traffic controls (e.g., lights, signs)
	Grade (v/h) Measurement a) at impact _____ b) between impact and final rest _____	* scaled representations of the vehicle and pedestrian at pre-impact, impact, and final rest based upon either:  a) physical evidence, or  b) reconstructed accident dynamics
* documentation of the physical plant including:  a) all road/roadway delineation (e.g., crosswalks, curb/edge lines, lane markings, medians, pavement markings, parked vehicles, poles, signs, etc.)  b) all traffic controls (e.g., lights, signs)	Pedestrian Travel Direction <u>WEST</u>	
	Vehicle Travel Direction <u>NORTH</u>	
	Number of Travel Lanes <u>2</u>	

Reference Point: SIGNAL POLE S.W. SIDE

Reference Line: SOUTHWEST CURBLINE

Item	Distance and Direction from Reference Point	Distance and Direction from Reference Line
<u>R.P</u>	<u>0.0</u>	<u>1.0 S</u>
<u>FIRE HYDRANT</u>	<u>1.7 E</u>	<u>0.8 S</u>
<u>LIGHT POLE</u>	<u>5.6 E</u>	<u>12.4 N</u>
<u>TELEPHONE</u>	<u>2.9 E</u>	<u>13.9 N</u>
<u>STOP SIGN</u>	<u>0.6 E</u>	<u>15.2 N</u>
<u>NO TURN ON RED SIGN</u>	<u>5.6 E</u>	<u>13.1 N</u>
<u>DRIVEWAY #1 EAST EDGE</u>	<u>2.0 W</u>	<u>8.7 N</u>
<u>DRIVEWAY #2 NORTH EDGE</u>	<u>6.0 E</u>	<u>13.4 N</u>



### CODES FOR CLASS OF VEHICLE

- (00) Not a motor vehicle
- (01) Subcompact/mini (wheelbase < 254 cm)
- (02) Compact (wheelbase ≥ 254 but < 265 cm)
- (03) Intermediate (wheelbase ≥ 265 but < 278 cm)
- (04) Full size (wheelbase ≥ 278 but < 291 cm)
- (05) Largest (wheelbase ≥ 291 cm)
- (09) Unknown passenger car size
- (11) Compact utility vehicle
- (12) Large utility vehicle (≤ 4,500 kgs GVWR)
- (13) Passenger van (≤ 4,500 kgs GVWR)
- (14) Other van (≤ 4,500 kgs GVWR)
- (15) Pickup truck (≤ 4,500 kgs GVWR)
- (18) Other truck (≤ 4,500 kgs GVWR)
- (19) Unknown light truck type

### CODES FOR GENERAL AREA OF DAMAGE (GAD)

#### CDS APPLICABLE VEHICLES

- (F) Front
- (R) Right side
- (L) Left side
- (U) Undercarriage
- (9) Unknown

### CODES FOR VEHICLE NUMBER OR OBJECT CONTACTED

Collision with Nonfixed Object

- (72) Pedestrian

PEDESTRIAN GENERAL VEHICLE FORM NATIONAL ACCIDENT SAMPLING SYSTEM  
PEDESTRIAN CRASH DATA STUDY

1. Primary Sampling Unit Number 40  
2. Case Number - Stratum 6 09 P  
A T  
3. Vehicle Number 01

OFFICIAL RECORDS

9. Police Reported Travel Speed 999  
Code to the nearest kmph (NOTE: 000 means less than 0.5 kmph)  
(160) 159.5 kmph and above  
(999) Unknown

\_\_\_ mph X 1.6093 = \_\_\_ kmph

10. Speed Limit 999  
(000) No statutory limit  
Code posted or statutory speed limit in kmph  
(999) Unknown

\_\_\_ mph X 1.6093 = \_\_\_ kmph

11. Police Reported Alcohol Presence For Driver 7  
(0) No alcohol present  
(1) Yes alcohol present  
(7) Not reported  
(8) No driver present  
(9) Unknown

12. Alcohol Test Result For Driver 96  
Code actual value (decimal implied before first digit—0.xx)  
(95) Test refused  
(96) None given  
(97) AC (Alcohol Content) test performed, results unknown  
(98) No driver present  
(99) Unknown

Source: \_\_\_\_\_

13. Police Reported Other Drug Presence For Driver 0  
(0) No other drug(s) present  
(1) Yes other drug(s) present  
(7) Not reported  
(8) No driver present  
(9) Unknown

14. Other Drug Specimen Test Result For Driver 0  
(0) No specimen test given  
(1) Drug not found in specimen  
(2) Drug found in specimen (specify): \_\_\_\_\_  
(3) Specimen test given, results unknown or not obtained  
(8) No driver present  
(9) Unknown

VEHICLE IDENTIFICATION

4. Vehicle Model Year 96  
Code the last two digits of the model year  
(99) Unknown

5. Vehicle Make (specify): 24  
SATURN  
Applicable codes are found in your NASS PCDS Data Collection, Coding and Editing Manual.  
(99) Unknown

6. Vehicle Model (specify): 003  
SW2 4DSN  
Applicable codes are found in your NASS PCDS Data Collection, Coding and Editing Manual.  
(999) Unknown

7. Body Type 04  
Note: Applicable codes may be found on the back of this page.

8. Vehicle Identification Number  
1 4 8 2 K 5 2 7 1 T Z  
1 2 3 4 5 6 7 8 9 10 11 12 13 14 15 16 17

Left justify; Slash zeros and letter Z (0 and Z)  
No VIN—Code all zeros  
Unknown—Code all nines



# CODES FOR BODY TYPE

## CDS APPLICABLE VEHICLES

### Automobiles

- (01) Convertible (excludes sun-roof, t-bar)
- (02) 2-door sedan, hardtop, coupe
- (03) 3-door/2-door hatchback
- (04) 4-door sedan, hardtop
- (05) 5-door/4-door hatchback
- (06) Station wagon (excluding van and truck based)
- (07) Hatchback, number of doors unknown
- (08) Other automobile type (specify): \_\_\_\_\_
- (09) Unknown automobile type

### Automobile Derivatives

- (10) Auto based pickup (includes El Camino, Caballero, Ranchero, Brat, and Rabbit pickup)
- (11) Auto based panel (cargo station wagon, auto based ambulance/hearse)
- (12) Large limousine - more than four side doors or stretched chassis
- (13) Three-wheel automobile or automobile derivative

### Utility Vehicles ( $\leq 4,500$ kgs GVWR)

- (14) Compact utility (Jeep CJ-2 - CJ-7, Scrambler, Golden Eagle, Renegade, Laredo, Wrangler, Cherokee [84 and after], Dispatcher, Raider, Bronco II, Bronco [76 and before], Explorer, S-10 Blazer, Geo Tracker, Bravada, S-15 Jimmy, Thing, Pathfinder, Trooper, Trooper II, Rodeo, Amigo, Navajo, 4-Runner, Montero, Samurai, Sidekick, Rocky)
- (15) Large utility (includes Jeep Cherokee [83 and before], Ramcharger, Trailduster, Bronco-fullsize [78 and after], fullsize Blazer, fullsize Jimmy, Landcruiser, Rover, Scout)
- (16) Utility station wagon (Chevy Suburban, GMC Suburban, Travelall, Grand Wagoneer, includes suburban limousine)
- (19) Utility, unknown body type

### Van Based Light Trucks ( $\leq 4,500$ kgs GVWR)

- (20) Minivan (Chrysler Town and Country, Caravan, Grand Caravan, Voyager, Grand Voyager, Mini-Ram, Dodge/Plymouth Vista, Aerostar, Villager, Lumina APV, Trans Sport, Silhouette, Astro, Safari, Toyota Van, Toyota Minivan, Previa, Nissan Minivan, Quest, Mitsubishi Minivan, Vanagon/Camper.)
- (21) Large van (B150-B350, Sportsman, Royal, Maxiwagon, Ram, Tradesman, Voyager [83 and before], E150-E350, Econoline, Clubwagon, Chateau, G10-G30, Chevy Van, Beauville, Sport Van, G15-G35, Rally Van, Vandura.)
- (22) Step van or walk-in van ( $\leq 4,500$  kgs GVWR)
- (23) Van based motorhome ( $\leq 4,500$  kgs GVWR)
- (24) Van based school bus ( $\leq 4,500$  kgs GVWR)
- (25) Van based other bus ( $\leq 4,500$  kgs GVWR)
- (28) Other van type (Hi-Cube Van, Kary) (specify): \_\_\_\_\_
- (29) Unknown van type

### Light Conventional Trucks (Pickup style cab, $\leq 4,500$ kgs GVWR)

- (30) Compact pickup (D50, Colt P/U, Ram 50, Dakota, Arrow Pickup [foreign], Ranger, Courier, S-10, T-10, LUV, S-15, T-15, Sonoma, Datsun/Nissan Pickup, P'up, Mazda Pickup, Toyota Pickup, Mitsubishi Pickup)
- (31) Large Pickup (Jeep Pickup, Comanche, Ram Pickup, D100-D350, W100-W350, F100-F350, C10-C35, K10-K35, R10-R35, V10-V35, Silverado, Sierra, R100-R500.)

- (32) Pickup with slide-in camper
- (33) Convertible pickup
- (39) Unknown pickup style light conventional truck type

### Other Light Trucks ( $\leq 4,500$ kgs GVWR)

- (40) Cab chassis based (includes rescue vehicles, light stake, dump, and tow truck)
- (41) Truck based panel
- (42) Light truck based motorhome (chassis mounted)
- (45) Other light conventional truck type
- (48) Unknown light truck type
- (49) Unknown light vehicle type (automobile, utility, van, or light truck)

## OTHER VEHICLES

### Buses (Excludes Van Based)

- (50) School bus (designed to carry students, not cross country or transit)
- (58) Other bus type (e.g., transit, intercity, bus based motorhome) (specify): \_\_\_\_\_
- (59) Unknown bus type

### Medium/Heavy Trucks ( $> 4,500$ kgs GVWR)

- (60) Step van ( $> 4,500$  kgs GVWR)
- (61) Single unit straight truck ( $4,500$  kgs  $<$  GVWR  $\leq 8,850$  kgs)
- (62) Single unit straight truck ( $8,850$  kgs  $<$  GVWR  $\leq 12,000$  kgs)
- (63) Single unit straight truck ( $> 12,000$  kgs GVWR)
- (64) Single unit straight truck, GVWR unknown
- (65) Medium/heavy truck based motorhome
- (67) Truck-tractor with no cargo trailer
- (68) Truck-tractor pulling one trailer
- (69) Truck-tractor pulling two or more trailers
- (70) Truck-tractor (unknown if pulling trailer)
- (78) Unknown medium/heavy truck type
- (79) Unknown truck type (light/medium/heavy)

### Motored Cycles (Does Not Include All-Terrain Vehicles/Cycles)

- (80) Motorcycle
- (81) Moped (motorized bicycle)
- (82) Three-wheel motorcycle or moped
- (88) Other motored cycle (minibike, motorscooter) (specify): \_\_\_\_\_
- (89) Unknown motored cycle type

### Other Vehicles

- (90) ATV (All-Terrain Vehicle) and ATC (All-Terrain Cycle)
- (91) Snowmobile
- (92) Farm equipment other than trucks
- (93) Construction equipment other than trucks
- (97) Other vehicle type
- (99) Unknown body type

## VEHICLE WEIGHT ITEMS

15. Vehicle Curb Weight 1.090  
 \_\_\_\_\_ Code weight to nearest  
 10 kilograms.  
 (045) Less than 450 kilograms  
 (610) 6,100 kilograms or more  
 (999) Unknown

2.400 lbs X .4536 = 1.091 kgs

Source: \_\_\_\_\_

16. Vehicle Cargo Weight 9.990  
 \_\_\_\_\_ Code weight to nearest  
 10 kilograms.  
 (000) Less than 5 kilograms  
 (450) 4,500 kilograms or more  
 (999) Unknown

\_\_\_\_\_ lbs X .4536 = \_\_\_\_\_ kgs

## OTHER DATA

17. Vehicle Special Use (This Trip) 0  
 (0) No special use  
 (1) Taxi  
 (2) Vehicle used as school bus  
 (3) Vehicle used as other bus  
 (4) Military  
 (5) Police  
 (6) Ambulance  
 (7) Fire truck or car  
 (8) Other (specify): \_\_\_\_\_  
 (9) Unknown

**STOP - VARIABLES 18 THROUGH 20  
 ARE COMPLETED BY THE ZONE CENTER**

## RECONSTRUCTION DATA

18. Impact Speed + 999  
 \_\_\_\_\_ Nearest kmph

(NOTE: 000 means greater than .5 kmph)  
 (160) 159.5 kmph and above  
 (999) Unknown

19. Accuracy Range of Impact Speed Estimate 9  
 (0) No reconstruction  
 (1) Less than 2 kmph  
 (2)  $\geq 2$  kmph and  $\leq 8$  kmph  
 (3)  $\geq 9$  kmph and  $\leq 16$  kmph  
 (4)  $\geq 17$  kmph and  $\leq 26$  kmph  
 (9) Unknown

20. Data Source of Impact Speed 0  
 (0) No impact speed calculated  
 (1) Zone center calculation  
 (2) Police calculation  
 (3) Driver/witness/police estimates

## PRECRASH DATA

21. Driver's Attention to Driving 4  
 (Prior to Recognition of Critical Event)  
 (1) Full attention to driving  
 (2) Distracted by other occupant  
 (3) Distracted by moving object in vehicle  
 (4) Distracted by outside person, object, or  
 event  
 (5) Talking on cellular phone or CB radio  
 Specify: \_\_\_\_\_  
 (6) Sleeping or dozing while driving  
 (8) Other (specify): \_\_\_\_\_  
 (9) Unknown

22. Pre-Event Vehicle Movement 10  
 (Prior to Recognition of Critical Event)  
 (01) Going straight  
 (02) Slowing or stopping in traffic lane  
 (03) Starting in traffic lane  
 (04) Stopped in traffic lane  
 (05) Passing or overtaking another vehicle  
 (06) Disabled or parked in travel lane  
 (07) Leaving a parking position  
 (08) Entering a parking position  
 (09) Turning right  
 (10) Turning left  
 (11) Making a U-turn  
 (12) Backing up (other than for parking position)  
 (13) Negotiating a curve  
 (14) Changing lanes  
 (15) Merging  
 (16) Successful avoidance maneuver to a  
 previous critical event  
 (97) Other (specify): \_\_\_\_\_  
 (98) No driver present  
 (99) Unknown

## 23. Critical Precrash Event

80*This Vehicle Loss of Control Due To:*

- (01) Blow out or flat tire
- (02) Stalled engine
- (03) Disabling vehicle failure (e.g., wheel fell off)  
(specify): \_\_\_\_\_
- (04) Non-disabling vehicle problem (e.g., hood flew up) (specify): \_\_\_\_\_
- (05) Poor road conditions (puddle, pot hole, ice, etc.)  
(specify): \_\_\_\_\_
- (06) Traveling too fast for conditions
- (08) Other cause of control loss (specify): \_\_\_\_\_

- (09) Unknown cause of control loss

*This Vehicle Traveling*

- (10) Over the lane line on left side of travel lane
- (11) Over the lane line on right side of travel lane
- (12) Off the edge of the road on the left side
- (13) Off the edge of the road on the right side
- (14) End departure
- (15) Turning left at intersection
- (16) Turning right at intersection
- (17) Crossing over (passing through) intersection
- (19) Unknown travel direction

*Other Motor Vehicle In Lane*

- (50) Stopped
- (51) Traveling in same direction with lower speed  
(i.e., lower steady speed or decelerating)
- (52) Traveling in same direction with higher speed
- (53) Traveling in opposite direction
- (54) In crossover
- (55) Backing
- (59) Unknown travel direction of other motor vehicle  
in lane

*Other Motor Vehicle Encroaching Into Lane*

- (60) From adjacent lane (same direction)—over left  
lane line
- (61) From adjacent lane (same direction)—over right  
lane line
- (62) From opposite direction—over left lane line
- (63) From opposite direction—over right lane line
- (64) From parking lane
- (65) From crossing street, turning into same direction
- (66) From crossing street, across path
- (67) From crossing street, turning into opposite  
direction
- (68) From crossing street, intended path not known
- (70) From driveway, turning into same direction
- (71) From driveway, across path
- (72) From driveway, turning into opposite direction
- (73) From driveway, intended path not known
- (74) From entrance to limited access highway
- (78) Encroachment by other vehicle—details  
unknown

*Pedestrian or Pedalcyclist, or Other Nonmotorist*

- (80) Pedestrian in roadway
- (81) Pedestrian approaching roadway
- (82) Pedestrian—unknown location

- (83) Pedalcyclist or other nonmotorist in roadway  
(specify): \_\_\_\_\_
- (84) Pedalcyclist or other nonmotorist approaching  
roadway (specify): \_\_\_\_\_
- (85) Pedalcyclist or other nonmotorist—unknown  
location (specify): \_\_\_\_\_

*Object or Animal*

- (87) Animal in roadway
- (88) Animal approaching roadway
- (89) Animal—unknown location
- (90) Object in roadway
- (91) Object approaching roadway
- (92) Object—unknown location
- (98) Other critical precrash event (specify): \_\_\_\_\_

- (99) Unknown

## 24. Attempted Avoidance Maneuver

01

- (00) No driver present
- (01) No avoidance actions
- (02) Braking (no lockup)
- (03) Braking (lockup)
- (04) Braking (lockup unknown)
- (05) Releasing brakes
- (06) Steering left
- (07) Steering right
- (08) Braking and steering left
- (09) Braking and steering right
- (10) Accelerating
- (11) Accelerating and steering left
- (12) Accelerating and steering right
- (98) Other action (specify): \_\_\_\_\_
- (99) Unknown

## 25. Precrash Stability After Avoidance Maneuver

1

- (0) No driver present
- (1) No avoidance maneuver
- (2) Tracking
- (3) Skidding longitudinally—rotation less than 30  
degrees
- (4) Skidding laterally—clockwise rotation
- (5) Skidding laterally—counterclockwise rotation
- (8) Other vehicle loss-of-control (specify): \_\_\_\_\_
- (9) Precrash stability unknown

26. Precrash Directional Consequences of  
Avoidance Maneuver (Corrective Action)1

- (0) No driver present
- (1) No avoidance maneuver
- (2) Vehicle stayed in travel lane where avoidance  
maneuver was initiated
- (3) Vehicle stayed on roadway but left travel lane  
where avoidance maneuver was initiated
- (4) Vehicle stayed on roadway, not known if left  
travel lane where avoidance maneuver was  
initiated
- (5) Vehicle departed roadway
- (6) Avoidance maneuver initiated off roadway
- (9) Directional consequences unknown

## ENVIRONMENTAL DATA

- |   |  |
|---|--|
| <p>27. Relation to Junction <u>3</u></p> <p>(0) Non-junction<br/>(1) Interchange area</p> <p><i>Non-Interchange</i></p> <p>(2) Intersection<br/>(3) Intersection-related<br/>(4) Drive, alley access related<br/>(5) Other non-interchange (specify): _____</p> <p>(6) Unknown type of non-interchange<br/>(9) Unknown if interchange</p> | <p>33. Roadway Surface Condition <u>1</u></p> <p>(1) Dry<br/>(2) Wet<br/>(3) Snow and slush<br/>(4) Ice<br/>(5) Sand, dirt or oil<br/>(8) Other (specify): _____<br/>(9) Unknown</p>   |
| <p>28. Trafficway Flow <u>1</u></p> <p>(1) Not physically divided (two way traffic)<br/>(2) Divided trafficway - median strip without positive barrier<br/>(3) Divided trafficway - median strip with positive barrier<br/>(4) One way trafficway<br/>(9) Unknown</p>   | <p>34. Traffic Control Device <u>1</u></p> <p>(0) No traffic control(s)<br/>(1) Trafficway traffic control signal (not RR crossing)</p> <p><i>Regulatory or School Zone Sign (Not RR Crossing)</i></p> <p>(2) Stop sign<br/>(3) Yield sign<br/>(4) School zone sign<br/>(5) Other sign (specify): _____</p> <p>(6) Unknown sign<br/>(7) Warning sign (not RR crossing)<br/>(8) Miscellaneous/other controls including RR controls (specify): _____<br/>(9) Unknown</p> |
| <p>29. Number of Travel Lanes <u>2</u></p> <p>(1) One<br/>(2) Two<br/>(3) Three<br/>(4) Four<br/>(5) Five<br/>(6) Six<br/>(7) Seven or more<br/>(9) Unknown</p>   | <p>35. Traffic Control Device Functioning <u>2</u></p> <p>(0) No traffic control<br/>(1) Not Functioning<br/>(2) Functioning<br/>(9) Unknown</p>   |
| <p>30. Roadway Alignment <u>1</u></p> <p>(1) Straight<br/>(2) Curve right<br/>(3) Curve left<br/>(9) Unknown</p>  | <p>36. Light Conditions <u>1</u></p> <p>(1) Daylight<br/>(2) Dark<br/>(3) Dark, but lighted<br/>(4) Dawn<br/>(5) Dusk<br/>(9) Unknown</p>  |
| <p>31. Roadway Profile <u>1</u></p> <p>(1) Level<br/>(2) Uphill Grade (&gt;2%)<br/>(3) Downhill Grade (&gt;2%)<br/>(4) Hillcrest<br/>(5) Sag<br/>(9) Unknown</p>  | <p>37. Atmospheric Conditions <u>1</u></p> <p>(1) No adverse atmospheric related driving conditions<br/>(2) Rain<br/>(3) Sleet<br/>(4) Snow<br/>(5) Fog<br/>(6) Rain and fog<br/>(7) Sleet and fog<br/>(8) Other (e.g., smog, smoke, blowing sand or dust, etc.) (specify): _____<br/>(9) Unknown</p>  |
| <p>32. Roadway Surface Type <u>2</u></p> <p>(1) Concrete<br/>(2) Bituminous (asphalt)<br/>(3) Brick or Block<br/>(4) Slag, gravel or stone<br/>(5) Dirt<br/>(8) Other (specify): _____<br/>(9) Unknown</p>  |  |

1. Primary Sampling Unit Number

20

3. Vehicle Number

0 1

2. Case Number - Stratum

6 09 P  
- 4 TT

**VEHICLE IDENTIFICATION**

VIN 1G8ZK5271T2

Model Year 96

Vehicle Make (specify): SATURN

Vehicle Model (specify): \_\_\_\_\_

40

**PEDESTRIAN FRONT CONTACT WORK SHEET**

PEV06 Hood Material

STEEL

PEV08 Hood Length

100 cm

PEV09 Hood Width-Forward Opening

127 cm

PEV10 Hood Width-Midway

139 cm

PEV11 Hood Width-Rear Opening

143 cm

PEV14 Front Bumper Cover Material

PLASTIC

PEV15 Front Bumper Reinforcement Material

STEEL

**VERTICAL MEASUREMENTS**

PEV16 Front Bumper-Bottom Height

38 cm

PEV17 Front Bumper-Top Height

50 cm

PEV18 Forward Hood Opening

62 cm

PEV19 Front Bumper Lead

10 cm

**WRAP DISTANCES**

PEV20 Ground to Forward Hood Opening

68 cm

PEV21 Ground to Front/Top Transition Point

87 cm

PEV22 Ground to Rear Hood Opening

168 cm

PEV23 Ground to Base of Windshield

179 cm

PEV24 Ground to Top of Windshield

265 cm

PEV25 Ground to Head Contact

998 cm

Origin 151

**VEHICLE DAMAGE SKETCH**

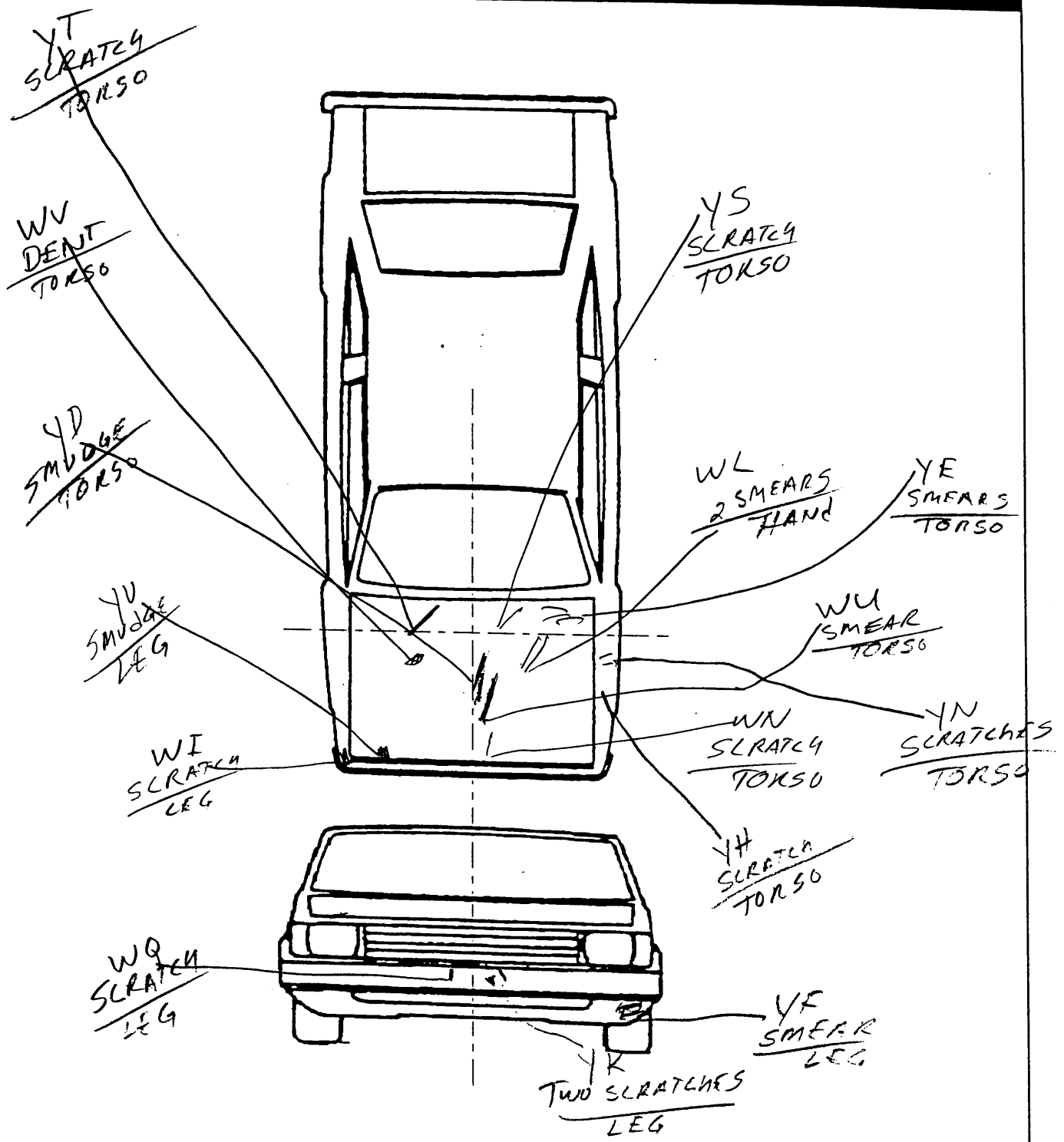

NOTES: Sketch all pedestrian contacts, include the size and depth in centimeters. Locate the pedestrian contacts from the intercept point of the centerline (lateral) and the front axles (longitudinal) in centimeters. Annotate observations which might be useful in reconstructing the accident (e.g., grass in tire bead, direction of striations, scuff on sidewalls, etc.).

Location of the origin (intercept point of the centerline and the front axles) from the ground: 151 cm

**PEDESTRIAN SIDE CONTACT WORK SHEET**

PEV06 Hood Material

PEV08 Hood Length

PEV09 Hood Width-Forward Opening

PEV10 Hood Width-Midway

PEV11 Hood Width-Rear Opening

\_\_\_\_\_ cm  
 \_\_\_\_\_ cm  
 \_\_\_\_\_ cm  
 \_\_\_\_\_ cm

**VERTICAL MEASUREMENTS**

PEV26 Ground Clearance

PEV27 Side Bumper-Bottom Height

PEV28 Side Bumper-Top Height

PEV29 Centerline of Wheel

PEV30 Top of Tire

PEV31 Top of Wheel Well Opening

PEV32 Bottom of A-Pillar at Windshield

PEV33 Top of A-Pillar at Windshield

PEV34 Top of Side View Mirror

\_\_\_\_\_ cm  
 \_\_\_\_\_ cm  
 \_\_\_\_\_ cm  
 \_\_\_\_\_ cm  
 \_\_\_\_\_ cm  
 \_\_\_\_\_ cm  
 \_\_\_\_\_ cm  
 \_\_\_\_\_ cm  
 \_\_\_\_\_ cm

**LATERAL MEASUREMENTS**PEV35  $C_L$  to A-Pillar at Bottom of WindshieldPEV36  $C_L$  to A-Pillar at Top of WindshieldPEV37  $C_L$  to Maximum Side View Mirror Protrusion

\_\_\_\_\_ cm  
 \_\_\_\_\_ cm  
 \_\_\_\_\_ cm

**WRAP DISTANCES**

PEV38 Ground to Side/Top Transition

PEV39 Ground to Hood Edge

PEV40 Ground to Centerline of Hood (ORIGIN)

PEV41 Ground to Head Contact

\_\_\_\_\_ cm  
 \_\_\_\_\_ cm  
 \_\_\_\_\_ cm  
 \_\_\_\_\_ cm

### VEHICLE DAMAGE SKETCH

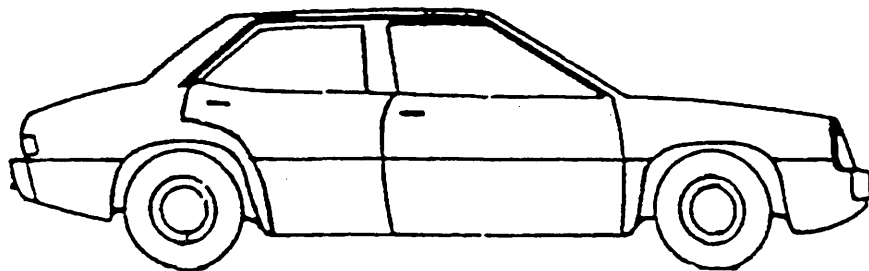
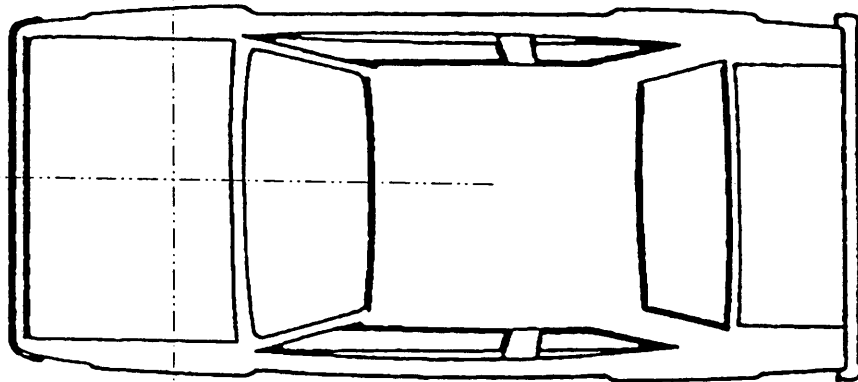
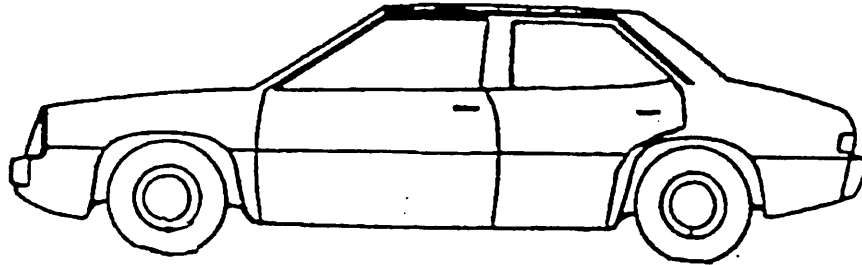

**NOTES:** Sketch all pedestrian contacts, include the size and depth in centimeters. Locate the pedestrian contacts from the intercept point of the centerline (lateral) and the front axles (longitudinal) in centimeters. Annotate observations which might be useful in reconstructing the accident (e.g., grass in tire bead, direction of striations, scuff on sidewalls, etc.).

Location of the origin (intercept point of the centerline and the front axles) from the ground: \_\_\_\_\_ cm



# ORIGINAL SPECIFICATIONS

Wheelbase	<u>102.4</u> inches	x 2.54 =	<u>260</u> cm
Overall Length	<u>176.8</u> inches	x 2.54 =	<u>449</u> cm
Maximum Width	<u>66.9</u> inches	x 2.54 =	<u>170</u> cm
Curb Weight	<u>2.400</u> pounds	x .4536 =	<u>1.091</u> kg
Average Track	<u>56.3</u> inches	x 2.54 =	<u>143</u> cm
Front Overhang	<u>38.2</u> inches	x 2.54 =	<u>97</u> cm
Rear Overhang	<u>37.0</u> inches	x 2.54 =	<u>94</u> cm
Undeformed End Width	_____ inches	x 2.54 =	_____ cm
Engine Size: cyl./displ.	_____ cc	x .001 =	<u>1.9</u> L
	_____ CID	x .0164 =	_____ L

## INJURY SOURCE

### FRONT

- 700 Front bumper
- 701 Front lower valance/spoiler
- 702 Front grille
- 703 Hood edge and/or trim
- 704 Hood ornament (fixed)
- 705 Hood ornament (spring loaded)
- 706 Headlight
- 707 Retractable headlight door (Open/Closed)
- 708 Turn signal/parking lights
- 718 Other front or add on object  
(specify): \_\_\_\_\_
- 719 Unknown front object

### Left Side Components

- 720 Front fender side surface
- 721 Front antenna
- 722 A1 pillar
- 723 A2 pillar
- 724 B pillar
- 725 C pillar
- 726 D pillar
- 728 Other pillar  
(specify): \_\_\_\_\_
- 729 Left side roof rail
- 730 Left side door surface
- 731 Left side door handle
- 732 Left side mirror fixed housing
- 733 Left side folding mirror
- 734 Left side glazing forward of B pillar
- 735 Left side glazing rearward of B pillar
- 736 Left side back fender or quarter panel
- 737 Rear antenna
- 738 Other left side object  
(specify): \_\_\_\_\_
- 739 Unknown left side component

### Right Side Components

- 740 Front fender side surface
- 741 Front antenna
- 742 A1 pillar
- 743 A2 pillar

- 744 B pillar
- 745 C pillar
- 746 D pillar
- 748 Other pillar (specify): \_\_\_\_\_
- 749 Right side roof rail
- 750 Right side door surface
- 751 Right side door handle
- 752 Right side mirror fixed housing
- 753 Right side folding mirror
- 754 Right side glazing forward of B pillar
- 755 Right side glazing rearward of B pillar
- 756 Rear antenna
- 757 Rear fender or quarter panel
- 758 Other right side object  
(specify): \_\_\_\_\_
- 759 Unknown right side component

### Back Components

- 760 Rear (back) bumper
- 761 Tailgate
- 762 Hatchback, vertical surface
- 768 Other back component  
(specify): \_\_\_\_\_
- 769 Unknown back component

### Top Components

- 770 Hood surface
- 771 Hood surface reinforced by under hood component
- 772 Front fender top surface
- 773 Cowl area
- 774 Wiper blade & mountings
- 775 Windshield glazing
- 776 Front header
- 777 Roof surface
- 778 Backlight glazing
- 779 Rear header
- 780 Hatchback
- 781 Rear trunk lid
- 788 Other top component (specify): \_\_\_\_\_
- 789 Unknown top component

### Wheels / tires

- 790 Left front wheel / tire
- 791 Right front wheel / tire
- 792 Left rear wheel / tire
- 793 Right rear wheel / tire
- 798 Other wheel / tire (specify): \_\_\_\_\_
- 799 Unknown wheel / tire

### Undercarriage components

- 800 Front cross member
- 801 Steering assembly/Front suspension
- 802 Oil pan
- 803 Exhaust system pipe
- 804 Transmission
- 805 Drive shaft
- 806 Catalytic converter
- 807 Muffler
- 808 Floor pan
- 809 Fuel tank
- 810 Rear suspension
- 818 Other undercarriage component  
(specify): \_\_\_\_\_
- 819 Unknown undercarriage component

### Accessories

- 820 Air scoop, deflector
- 821 Cellular or CB radio antenna
- 822 Emergency lights or bar
- 823 Fog lights
- 824 Luggage, ski, or bike rack
- 825 Cargo (specify): \_\_\_\_\_
- 826 Spare tire
- 827 Spotlight
- 828 Other accessory (specify): \_\_\_\_\_

### Other Object or Vehicle in Environment

- 947 Ground
- 948 Other object (specify): \_\_\_\_\_
- 949 Unknown object in environment
- 959 Unknown object on contacting vehicle
- 997 Noncontact injury source
- 999 Unknown injury source

**POINTS OF PEDESTRIAN CONTACT**

**PEDESTRIAN CONTACT WORKSHEET**

CONTACT ID LABEL	COMPONENT CONTACTED	LONGITUDINAL LOCATION (X)	LATERAL LOCATION (Y)	CRUSH IN CENTIMETERS	SUSPECTED BODY REGION	SUPPORTING PHYSICAL EVIDENCE	CONFIDENCE LEVEL OF CONTACT POINT (Circle)	SEQUENCE #
WI	BUMPER	61	72		LEG	SCRATCH	① 2 3 9	6
YU	Hood	68	48		LEG	SMUDGE	① 2 3 9	5
WQ	BUMPER	53	11		LEG	SCRATCH	0 2 3 9	9
YK	"	53	-13		LEG	SCRATCHES	① 2 3 9	10
WN	Hood	71	-8		TORSO	SCRATCH	① 2 3 9	11
WY	Hood	85	-5		TORSO	SMEAR	① 2 3 9	2
YD	"	107	-3		TORSO	SMEAR	① 2 3 9	1
WV	"	132	33		TORSO	DENT	① 2 3 9	4
WL	"	123	-22		HAND	2 SMEARS	① 2 3 9	3
YT	"	151	39		TORSO	SCRATCH	③ 2 3 9	12
YS	"	157	-11		TORSO	SCRATCH	1 ② 3 9	13
YE	"	157	-28		TORSO	SMEARS	① 2 3 9	8
YH	LT FENDER	121	-77		TORSO	SCRATCH	1 ② 3 9	14
YI	LT FENDER	140	-5		TORSO	SCRATCHES	1 ② 3 9	15
YF	BUMPER	44	-56		LEG	SMEAR	① 2 3 9	7
							1 2 3 9	
							1 2 3 9	
							1 2 3 9	
							1 2 3 9	
							1 2 3 9	
							1 2 3 9	
							1 2 3 9	
							1 2 3 9	
							1 2 3 9	
							1 2 3 9	
							1 2 3 9	

POINTS OF PEDESTRIAN CONTACT							
CHRONOLOGICAL ORDER OF CONTACTS							
CONTACT #	COMPONENT CONTACTED CODE	LONGITUDINAL LOCATION (X)	LATERAL LOCATION (Y)	CRUSH IN CENTIMETERS	SUSPECTED BODY REGION	SUPPORTING PHYSICAL EVIDENCE	CONFIDENCE LEVEL OF CONTACT POINT (Circle)
1	770	107	-3		TORSO	SMEAR	① 2 3 9
2	770	85	-5		TORSO	SMEAR	① 2 3 9
3	770	123	-22		HAND	SMEARS	① 2 3 9
4	770	132	33		TORSO	JENT	① 2 3 9
5	770	68	48		LEG	SMUDGE	① 2 3 9
6	700	61	72		LEG	SCRATCH	① 2 3 9
7	700	44	-56		LEG	SMEAR	① 2 3 9
8	770	157	-28		TORSO	SMEARS	① 2 3 9
9	700	53	11		LEG	SCRATCH	① 2 3 9
10	700	53	-13		LEG	SCRATCHES	① 2 3 9
11	770	71	-8		TORSO	SCRATCH	① 2 3 9
12	770	151	39		TORSO	SCRATCH	① 2 3 9
13	770	157	-11		TORSO	SCRATCH	1 ② 3 9
14	720	121	-77		TORSO	SCRATCH	1 ② 3 9
15	720	140	-75		TORSO	SCRATCHES	1 ② 3 9
16							1 2 3 9
17							1 2 3 9
18							1 2 3 9
19							1 2 3 9
20							1 2 3 9
21							1 2 3 9
22							1 2 3 9
23							1 2 3 9
24							1 2 3 9
25							1 2 3 9

## VEHICLE DIMENSIONS

4. Original Wheelbase 260  
 \_\_\_\_\_ Code to the  
 nearest centimeter  
 (999) Unknown

102.4 inches X 2.54 = 260 centimeters

5. Original Average Track Width 143  
 \_\_\_\_\_ Code to the  
 nearest centimeter  
 (185) 185 centimeters or more  
 (999) Unknown

56.3 inches X 2.54 = 143 centimeters

6. Hood Material 3  
 (1) Plastic  
 (2) Fiberglass  
 (3) Steel  
 (4) Aluminum  
 (5) Stainless Steel  
 (8) Other (specify): \_\_\_\_\_  
 (9) Unknown

7. Hood Original 1  
 Equipment Manufacturer (OEM)  
 (1) OEM factory installed hood  
 (2) OEM replacement  
 (3) Non-OEM replacement  
 (9) Unknown

8. Hood Length 100  
 \_\_\_\_\_ Code to the  
 nearest centimeter  
 (180) 180 centimeters or more  
 (999) Unknown

39.3 inches X 2.54 = 100 centimeter

9. Hood Width Forward Opening 127  
 \_\_\_\_\_ Code to the  
 nearest centimeter  
 (210) 210 centimeters or more  
 (999) Unknown

50.0 inches X 2.54 = 127 centimeters

10. Hood Width Midway 139  
 \_\_\_\_\_ Code to the  
 nearest centimeter  
 (210) 210 centimeters or more  
 (999) Unknown

54.7 inches X 2.54 = 139 centimeters

11. Hood Width Rear Opening 143  
 \_\_\_\_\_ Code to the  
 nearest centimeter  
 (210) 210 centimeters or more  
 (999) Unknown

56.3 inches X 2.54 = 143 centimeters

12. Hood/Fender Vertical/Lateral Crush From Pedestrian 1  
 (0) Not damaged  
 (1) Surface scratching only, no residual crush  
 (2) Minor crush (1-3 centimeters)  
 (3) Moderate crush (4-7 centimeters)  
 (4) Severe crush (>7 centimeters)  
 (8) Damage present, unknown if damage is from pedestrian impact  
 (9) Unknown

13. Windshield Contact Damage From Pedestrian Contact 0  
 (0) Not contacted by pedestrian  
 (1) Contacted by pedestrian - not damaged  
 (2) Contacted by pedestrian - damaged  
 (3) Unknown if contacted by pedestrian - not damaged  
 (4) Unknown if contacted by pedestrian - damaged  
 (9) Unknown if contacted by pedestrian - unknown if damaged

## FRONT CONTACT DAMAGE

## Front Vertical Measurements

14. Front Bumper Cover Material 1  
 (0) No front contact  
 (1) Plastic  
 (2) Fiberglass  
 (3) Rubber  
 (4) Other (specify): \_\_\_\_\_  
 (9) Unknown

15. Front Bumper Reinforcement Material 1  
 (0) No front contact  
 (1) Steel  
 (2) Aluminum  
 (3) Stainless Steel  
 (4) Other (specify): \_\_\_\_\_  
 (9) Unknown

16. Front Bumper-Bottom Height 038  
 \_\_\_\_\_ Code to the  
 nearest centimeter  
 (000) No front contact  
 (150) 150 centimeters or more  
 (999) Unknown

15.0 inches X 2.54 = 38 centimeters

17. Front Bumper-Top Height 050  
 \_\_\_\_\_ Code to the  
 nearest centimeter  
 (000) No front contact  
 (150) 150 centimeters or more  
 (999) Unknown

19.7 inches X 2.54 = 50 centimeters

18. Forward Hood Opening 062  
 \_\_\_\_\_ Code to the  
 nearest centimeter  
 (000) No front contact  
 (200) 200 centimeters or more  
 (999) Unknown

24.4 inches X 2.54 = 62 centimeters

19. Front Bumper Lead 10  
 (00) No front contact  
 \_\_\_\_\_ Code to the  
 nearest centimeter  
 (30) 30 centimeters or more  
 (99) Unknown

3.9 inches X 2.54 = 10 centimeters

23. Ground to Base of Windshield 179  
 \_\_\_\_\_ Code to the  
 nearest centimeter  
 (000) No front contact  
 (400) 400 centimeters or more  
 (999) Unknown

70.5 inches X 2.54 = 179 centimeters

24. Ground to Top of Windshield 265  
 \_\_\_\_\_ Code to the  
 nearest centimeter  
 (000) No front contact  
 (500) 500 centimeters or more  
 (999) Unknown

104.3 inches X 2.54 = \_\_\_\_\_ centimeters

25. Ground To Head Contact 998  
 \_\_\_\_\_ Code to the  
 nearest centimeter  
 (000) No front contact  
 (400) 400 centimeters or more  
 (998) No head contact  
 (999) Unknown

\_\_\_\_\_ inches X 2.54 = \_\_\_\_\_ centimeters

#### Front Wrap Distance Measurements

20. Ground to Forward Hood Opening 068  
 \_\_\_\_\_ Code to the  
 nearest centimeter  
 (000) No front contact  
 (200) 200 centimeters or more  
 (999) Unknown

26.8 inches X 2.54 = 68 centimeters

21. Ground to Front/Top Transition Point 087  
 \_\_\_\_\_ Code to the  
 nearest centimeter  
 (000) No front contact  
 (180) 180 centimeters or more  
 (999) Unknown

34.3 inches X 2.54 = 87 centimeters

22. Ground to Rear Hood Opening 168  
 \_\_\_\_\_ Code to the  
 nearest centimeter  
 (000) No front contact  
 (400) 400 centimeters or more  
 (999) Unknown

66.1 inches X 2.54 = 168 centimeters

#### SIDE CONTACT DAMAGE

##### Side Vertical Measurements

26. Ground Clearance 000  
 \_\_\_\_\_ Code to the  
 nearest centimeter  
 (000) No side contact  
 (150) 150 centimeters or more  
 (999) Unknown







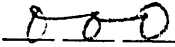

\_\_\_\_\_ inches X 2.54 = \_\_\_\_\_ centimeters

27. Side Bumper-Bottom Height 000  
 \_\_\_\_\_ Code to the  
 nearest centimeter  
 (000) No side contact  
 (150) 150 centimeters or more  
 (999) Unknown

\_\_\_\_\_ inches X 2.54 = \_\_\_\_\_ centimeters

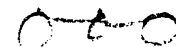
28. Side Bumper-Top Height 000  
 \_\_\_\_\_ Code to the  
 nearest centimeter  
 (000) No side contact  
 (150) 150 centimeters or more  
 (999) Unknown

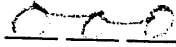
\_\_\_\_\_ inches X 2.54 = \_\_\_\_\_ centimeters

		Side Lateral Measurements	
<p>29. Centerline of Wheel                      _____ Code to the nearest centimeter                      (000) No side contact                      (150) 150 centimeters or more                      (999) Unknown</p> <p>_____ . ____ inches X 2.54 = _____ centimeters</p>		<p>35. Centerline to A-Pillar at Bottom of Windshield                      (000) No side contact                      _____ Code to the nearest centimeter                      (250) 250 centimeters or more                      (999) Unknown</p> <p>_____ . ____ inches X 2.54 = _____ centimeters</p>	
<p>30. Top of Tire                      _____ Code to the nearest centimeter                      (000) No side contact                      (200) 200 centimeters or more                      (999) Unknown</p> <p>_____ . ____ inches X 2.54 = _____ centimeters</p>		<p>36. Centerline to A-Pillar at Top of Windshield                      _____ Code to the nearest centimeter                      (000) No side contact                      (250) 250 centimeters or more                      (999) Unknown</p> <p>_____ . ____ inches X 2.54 = _____ centimeter</p>	
<p>31. Top of Wheel Well Opening                      _____ Code to the nearest centimeter                      (000) No side contact                      (250) 250 centimeters or more                      (999) Unknown</p> <p>_____ . ____ inches X 2.54 = _____ centimeters</p>		<p>37. Centerline to Maximum Side View Mirror Protrusion                      _____ Code to the nearest centimeter                      (000) No side contact                      (300) 300 centimeters or more                      (999) Unknown</p> <p>_____ . ____ inches X 2.54 = _____ centimeter</p>	
<p>32. Bottom of A-Pillar at Windshield                      _____ Code to the nearest centimeter                      (000) No side contact                      (250) 250 centimeters or more                      (999) Unknown</p> <p>_____ . ____ inches X 2.54 = _____ centimeters</p>		Side Wrap Distance Measurements	
<p>33. Top of A-Pillar at Windshield                      _____ Code to the nearest centimeter                      (000) No side contact                      (300) 300 centimeters or more                      (999) Unknown</p> <p>_____ . ____ inches X 2.54 = _____ centimeters</p>		<p>38. Ground to Side/Top Transition                      _____ Code to the nearest centimeter                      (000) No side contact                      (400) 400 centimeters or more                      (999) Unknown</p> <p>_____ . ____ inches X 2.54 = _____ centimeters</p>	
<p>34. Top of Side View Mirror                      _____ Code to the nearest centimeter                      (000) No side contact                      (300) 300 centimeters or more                      (999) Unknown</p> <p>_____ . ____ inches X 2.54 = _____ centimeters</p>		<p>39. Ground to Hood Edge                      _____ Code to the nearest centimeter                      (000) No side contact                      (500) 500 centimeters or more                      (999) Unknown</p> <p>_____ . ____ inches X 2.54 = _____ centimeters</p>	

40. Ground to Centerline of Hood

000

Code to the nearest centimeter

- (000) No side contact
- (700) 700 centimeters or more
- (999) Unknown

\_\_\_\_\_ inches X 2.54 = \_\_\_\_\_ centimeters

41. Ground to Head Contact

000

Code to the nearest centimeter

- (000) No side contact
- (800) 800 centimeters or more
- (998) No head contact
- (999) Unknown

\_\_\_\_\_ inches X 2.54 = \_\_\_\_\_ centimeters

# PEDESTRIAN ASSESSMENT FORM

1. Primary Sampling Unit Number 40  
2. Case Number - Stratum 609 P  
47  
3. Pedestrian Number 01

10. Pedestrian's Weight 020  
Code actual weight to the nearest  
kilogram.  
(999) Unknown  
43 pounds X .4536 = 20 kilograms

## PEDESTRIAN'S CHARACTERISTICS

4. Pedestrian's Age 03  
Code actual age at time of accident.  
(00) Less than one year old (specify by month):  
(97) 97 years and older  
(99) Unknown  
5. Pedestrian's Sex 1  
(1) Male  
(2) Female - not reported pregnant  
(3) Female - pregnant-1st trimester (1st-3rd month)  
(4) Female - pregnant-2nd trimester (4th-6th month)  
(5) Female - pregnant-3rd trimester (7th-9th month)  
(6) Female - pregnant-term unknown  
(9) Unknown  
6. Pedestrian's Overall Height 103  
Code actual height to the nearest  
centimeter.  
(999) Unknown  
41 inches X 2.54 = 103 centimeters  
7. Pedestrian's Height - Ground to Knee 27  
Code to the nearest  
centimeter.  
(999) Unknown  
11 inches X 2.54 = 27 centimeters  
8. Pedestrian's Height - Ground to Hip 050  
Code to the nearest  
centimeter.  
(999) Unknown  
20 inches X 2.54 = 50 centimeters  
9. Pedestrian's Height - Ground to Shoulder 078  
Code to the nearest  
centimeter.  
(999) Unknown  
31 inches X 2.54 = 78 centimeters

## PEDESTRIAN'S PRE-AVOIDANCE ACTIONS

11. Pedestrian Attitude 1  
(1) Standing  
(2) Crouching  
(3) Kneeling  
(4) Bending at waist  
(8) Other (specify):  
(9) Unknown  
12. Pedestrian Motion 1  
(0) Not moving  
(1) Walking slowly  
(2) Walking rapidly  
(3) Running or jogging  
(4) Hopping  
(5) Skipping  
(6) Jumping  
(7) Falling/stumbling or rising  
(8) Other (specify):  
(9) Unknown  
13. Pedestrian's Action Relative to Vehicle 01  
(00) Stopped  
(01) Crossing road, straight  
(02) Crossing road, diagonally  
(03) Moving in road, with traffic  
(04) Moving in road, against traffic  
(05) Off road, approaching road  
(06) Off road, going away from road  
(07) Off road, moving parallel  
(08) Off road, crossing driveway  
(09) Off road, moving along driveway  
(98) Other (specify):  
(99) Unknown  
14. Pedestrian's Body (Chest) Orientation  
Relative to Striking Vehicle Prior to  
Avoidance Actions 3  
(1) Facing vehicle  
(2) Facing away  
(3) Left side to vehicle  
(4) Right side to vehicle  
(8) Other (specify):  
(9) Unknown



**PEDESTRIAN'S AVOIDANCE ACTIONS**15. Pedestrian's First Avoidance Actions 00

- (00) No avoidance actions
- (01) Stopped
- (02) Accelerated pace
- (03) Ran away (along vehicle path)
- (04) Jumped
- (05) Turned toward vehicle
- (06) Turned away from vehicle
- (07) Dove or fell away

## Used hand(s) to :

- (11) Vault corner of vehicle
- (12) Vault onto vehicle
- (13) Brace against vehicle
- (14) Crouched and braced hands against vehicle
- (98) Other (specify): \_\_\_\_\_
- (99) Unknown

**PEDESTRIAN'S ORIENTATION AT IMPACT**16. Pedestrian's Head Orientation  
at Initial Impact 1

- (1) To front
- (2) To left
- (3) To right
- (4) Up
- (5) Down
- (8) Other (specify): \_\_\_\_\_
- (9) Unknown

17. Pedestrian's Body (Chest) Orientation  
at Initial Impact 3

- (1) Facing vehicle
- (2) Facing away
- (3) Left side to vehicle
- (4) Right side to vehicle
- (8) Other (specify): \_\_\_\_\_
- (9) Unknown

18. Pedestrian's Arm Orientation  
at Initial Impact 01

- (01) At sides
- (02) Folded across chest
- (03) Hands clasped behind back
- (04) Hands on hips
- (05) Hands in pockets

## One or both arms:

- (06) Extended upward
- (07) Extended to side
- (08) Extended forward bracing
- (09) Extended, holding object  
(briefcase, suitcase, etc.)
- (10) Holding object (young child,  
grocery bag, etc.) in arm(s)
- (11) Holding object (young child, grocery  
bag, etc.) on shoulder(s) or head
- (98) Other (specify): \_\_\_\_\_
- (99) Unknown

19. Pedestrian's Leg Orientation  
at Initial Impact 99

- (01) Together
- (02) Apart-laterally
- (03) Apart-right leg forward
- (04) Apart-left leg forward
- (05) Apart- forward leg unknown
- (06) Left foot off the ground
- (07) Right foot off the ground
- (08) Both feet off the ground
- (98) Other (specify): \_\_\_\_\_
- (99) Unknown

20. Vehicle/Pedestrian's Interaction 08

- (01) Carried by vehicle, wrapped position
- (02) Carried by vehicle, slid to windshield
- (03) Carried by vehicle, position unknown
- (04) Passed over vehicle top
- (05) Thrown straight forward
- (06) Thrown forward and left of vehicle
- (07) Thrown forward and right of vehicle
- (08) Knocked to pavement, forward
- (09) Knocked to pavement, left of vehicle
- (10) Knocked to pavement, right of vehicle
- (11) Knocked to pavement, run over or  
dragged by vehicle
- (12) Shunted to left (corner impacts only)
- (13) Shunted to right (corner impacts only)
- (14) Bumped or pushed aside
- (15) Snagged, rotated
- (16) Snagged, dragged by vehicle
- (17) Foot or legs run over
- (98) Other (specify): \_\_\_\_\_
- (99) Unknown

## OFFICIAL RECORDS

## INJURY CONSEQUENCES

21. Police Reported Alcohol Presence  
For Pedestrian

- (0) No alcohol present  
(1) Yes alcohol present  
(7) Not reported  
(9) Unknown

7

22. Alcohol Test Result For Pedestrian  
Code actual value (decimal implied  
before first digit—0.xx)

- (95) Test refused  
(96) None given  
(97) AC (Alcohol Content)  
test performed, results unknown  
(99) Unknown if test given

96

Source: \_\_\_\_\_

23. Police Reported Other Drug Presence  
For Pedestrian

- (0) No other drug(s) present  
(1) Yes other drug(s) present  
(7) Not reported  
(9) Unknown

0

24. Other Drug Specimen Test Result  
For Pedestrian

- (0) No specimen test given  
(1) Drug not found in specimen  
(2) Drug found in specimen,  
(specify): \_\_\_\_\_  
(3) Specimen test given,  
results unknown or not obtained  
(9) Unknown

0

25. Injury Severity (Police Rating)

- (0) O - No injury  
(1) C - Possible injury  
(2) B - Nonincapacitating injury  
(3) A - Incapacitating injury  
(4) K - Killed  
(5) U - Injury, severity unknown  
(6) Died prior to accident  
(9) Unknown

1 C

26. Treatment - Mortality

- (0) No treatment  
(1) Fatal  
(2) Fatal - ruled disease (specify):  
\_\_\_\_\_

4

*Nonfatal*

- (3) Hospitalization  
(4) Transported and released  
(5) Treatment at scene - non-transported  
(6) Treatment later  
(8) Treatment - other (specify):  
\_\_\_\_\_

- (9) Unknown

27. Type Of Medical Facility  
(for Initial Treatment)

- (0) Not treated at a medical facility  
(1) Trauma center  
(2) Hospital  
(3) Medical clinic  
(4) Physician's office  
(5) Treatment later at medical facility  
(8) Other (specify): \_\_\_\_\_  
(9) Unknown

2

28. Hospital Stay

- (00) Not Hospitalized  
\_\_\_\_\_ Code the number of days (up through 60)  
that the pedestrian stayed in a hospital.  
(61) 61 days or more  
(99) Unknown

00

29. Working Days Lost

- \_\_\_\_\_ Code the number of days  
(up through 60) that the pedestrian  
lost from work due to the accident  
(00) No working days lost  
(61) 61 days or more  
(62) Fatally injured  
(97) Not working prior to accident  
(99) Unknown

97

STOP - VARIABLES 30 THROUGH 37 ARE COMPLETED BY THE ZONE CENTER

30. Glasgow Coma Scale (GCS) Score 15  
 (at Medical Facility)  
 (00) Not injured  
 (01) Injured - not treated at medical facility  
 (02) No GCS Score at medical facility  
 (03-15) Code the actual value of the initial GCS Score recorded at medical facility.  
 (97) Injured, details unknown  
 (99) Unknown if injured

31. Was the Pedestrian Given Blood? 1  
 (1) No - blood not given  
 (2) Yes - blood given (specify units): \_\_\_\_\_  
 (9) Unknown if blood given

32. Arterial Blood Gases (ABG) - HCO<sub>3</sub> 01  
 (00) Not injured  
 (01) Injured, ABGs not measured or reported  
 (02-50) Code the actual value of the HCO<sub>3</sub>  
 (96) ABGs reported, HCO<sub>3</sub> unknown  
 (97) Injured, details unknown  
 (99) Unknown if injured

33. Time to Death 00  
 \_\_\_\_\_ Code number of hours from time of accident to time of death up through 24 hours. If time of death is greater than 24 hours, code number of days. (Note: 1 day = 31, 2 days = 32, ... n days = 30 + n up through 30 days = 60)  
 (00) Not fatal  
 (96) Fatal - ruled disease  
 (99) Unknown

34. 1st Medically Reported Cause of Death 00

35. 2nd Medically Reported Cause of Death 00

36. 3rd Medically Reported Cause of Death 00  
 \_\_\_\_\_ Code the Pedestrian Injury from line number(s) for the medically reported injury(s) which reportedly contributed to this pedestrian's death  
 (00) Not fatal or no additional causes  
 (96) Mode of death given but specific injuries are not linked to cause of death. (specify): \_\_\_\_\_  
 (97) Other result (includes fatal ruled disease) (specify): \_\_\_\_\_  
 (99) Unknown

37. Number of Recorded Injuries for This Pedestrian 04  
 \_\_\_\_\_ Code the actual number of injuries recorded for this pedestrian.  
 (00) No recorded injuries  
 (97) Injured, details unknown  
 (99) Unknown if injured

ARE ALL APPLICABLE MEDICAL RECORDS INCLUDED WITH INITIAL SUBMISSION?

NO [ ] YES [X]

UPDATE CANDIDATE? NO [X] YES [ ]

# PEDESTRIAN INJURY FORM

1. Primary Sampling Unit Number 40

3. Pedestrian Number 0 1

2. Case Number - Stratum 6 09 P  
AT

4. Blank X X

## INJURY DATA

Record below the actual injuries sustained by this pedestrian in CHRONOLOGICAL order that were identified from the official and unofficial data sources. Remember not to double count an injury just because it was identified from two different sources. If greater than twenty-five injuries have been documented, encode the balance on the Pedestrian Injury Supplement.

⑤ *abrasion*  
*forehead*  
*abrasion*  
④ *abrasion*  
*facial contusion*

Source of Injury Data	Body Region	AIS-90					Injury Source	Injury Confidence Level	Direct/Indirect Injury	Striking Profile	Type Of Damage	Damage Depth	
		Type of Anatomic Structure	Specific Anatomic Structure	Level of Injury	A.I.S. Severity	Aspect							
1st	5. <u>3</u>	6. <u>2</u>	7. <u>9</u>	8. <u>72</u>	9. <u>02</u>	10. <u>1</u>	11. <u>2</u>	12. <u>703</u>	13. <u>1</u>	14. <u>1</u>	15. <u>3</u>	16. <u>2</u>	17. <u>2</u>
2nd	18. <u>3</u>	19. <u>2</u>	20. <u>9</u>	21. <u>02</u>	22. <u>02</u>	23. <u>1</u>	24. <u>7</u>	25. <u>703</u>	26. <u>1</u>	27. <u>1</u>	28. <u>3</u>	29. <u>2</u>	30. <u>2</u>
3rd	31. <u>3</u>	32. <u>1</u>	33. <u>9</u>	34. <u>02</u>	35. <u>02</u>	36. <u>1</u>	37. <u>2</u>	38. <u>703</u>	39. <u>1</u>	40. <u>1</u>	41. <u>3</u>	42. <u>2</u>	43. <u>2</u>
4th	44. <u>3</u>	45. <u>2</u>	46. <u>9</u>	47. <u>04</u>	48. <u>02</u>	49. <u>1</u>	50. <u>9</u>	51. <u>703</u>	52. <u>1</u>	53. <u>1</u>	54. <u>3</u>	55. <u>2</u>	56. <u>2</u>
5th	57. ___	58. ___	59. ___	60. ___	61. ___	62. ___	63. ___	64. ___	65. ___	66. ___	67. ___	68. ___	69. ___
6th	70. ___	71. ___	72. ___	73. ___	74. ___	75. ___	76. ___	77. ___	78. ___	79. ___	80. ___	81. ___	82. ___
7th	83. ___	84. ___	85. ___	86. ___	87. ___	88. ___	89. ___	90. ___	91. ___	92. ___	93. ___	94. ___	95. ___
8th	96. ___	97. ___	98. ___	99. ___	100. ___	101. ___	102. ___	103. ___	104. ___	105. ___	106. ___	107. ___	108. ___
9th	109. ___	110. ___	111. ___	112. ___	113. ___	114. ___	115. ___	116. ___	117. ___	118. ___	119. ___	120. ___	121. ___
10th	122. ___	123. ___	124. ___	125. ___	126. ___	127. ___	128. ___	129. ___	130. ___	131. ___	132. ___	133. ___	134. ___



OFFICIAL INJURY DATA — SOFT TISSUE INJURIES

BEST AVAILABLE

Indicate the Location, Specific Anatomic Structure, Detail (size, depth, fracture type, head injury clinical signs and neurological deficits), and Source of all injuries indicated by official sources (or from PAR or other unofficial sources if medical records and interviewee data are unavailable.)

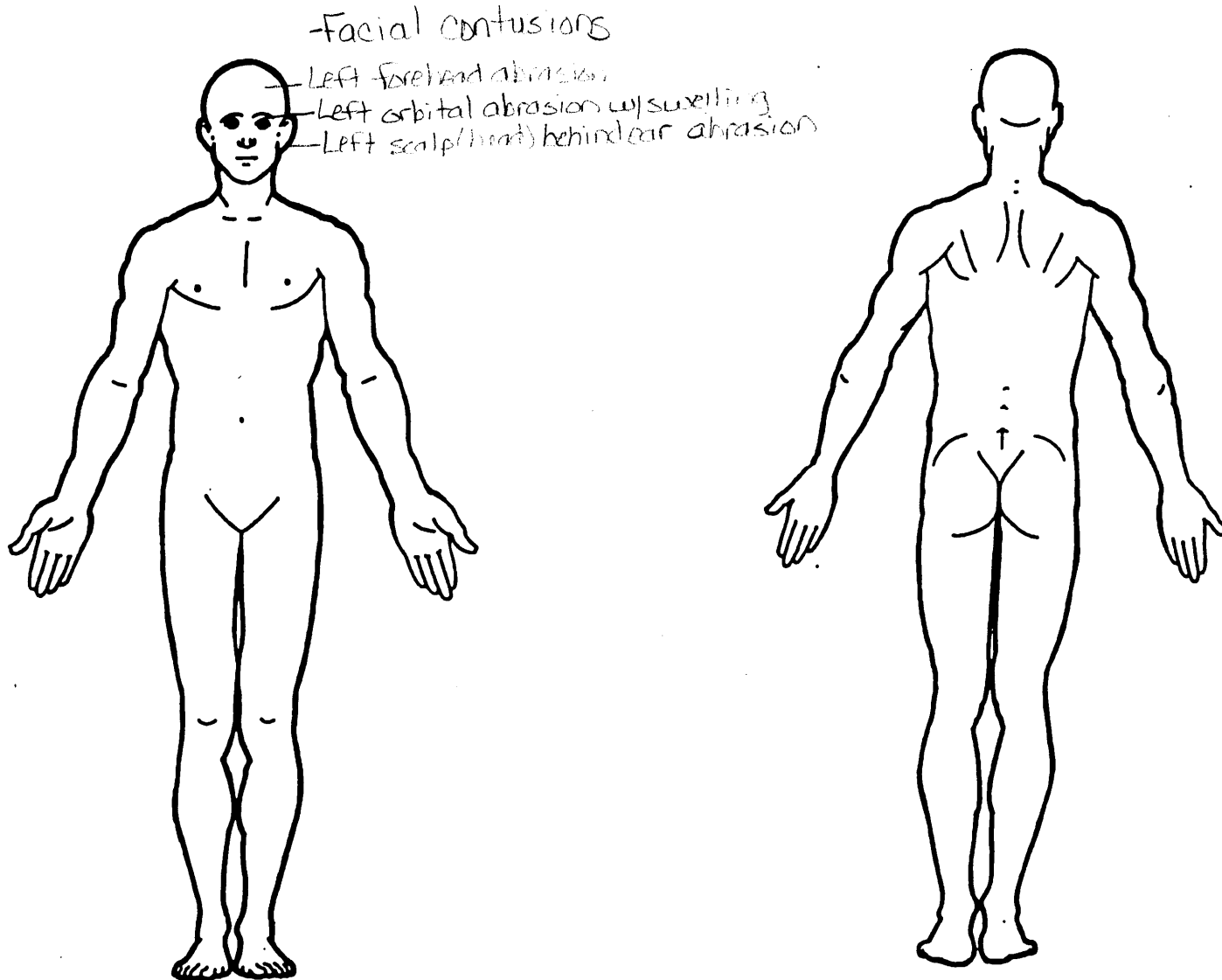



**SOURCE OF INJURY DATA****OFFICIAL**

- (1) Autopsy records with or without hospital/medical records
- (2) Hospital/medical records other than emergency room (e.g., discharge summary)
- (3) Emergency room records only (including associated X-rays or other lab reports)
- (4) Private physician, walk-in or emergency clinic

**UNOFFICIAL**

- (5) Lay coroner report
- (6) E.M.S. personnel
- (7) Interviewee
- (8) Other source (specify): \_\_\_\_\_
- (9) Police

**INJURY SOURCE CONFIDENCE LEVEL**

- (1) Certain
- (2) Probable
- (3) Possible
- (9) Unknown

**DIRECT/INDIRECT INJURY**

- (1) Direct contact injury
- (2) Indirect contact injury
- (3) Noncontact injury
- (7) Injured, unknown source

**STRIKING PROFILE**

- (0) Injury not from vehicle contact
- (1) Flat-Narrow (<15 centimeters)
- (2) Flat-Wide (> 15 centimeters)
- (3) Rounded (contoured)
- (4) Rounded edge
- (5) Sharp edge
- (8) Other (specify): \_\_\_\_\_
- (9) Unknown

**TYPE OF DAMAGE**

- (0) Injury not from vehicle contact
- (1) No damage/contact
- (2) Scratch (Scuff, Cloth Transfer, Smear)
- (3) Dent
- (4) Large deformation
- (5) Cracked, fractured, shattered
- (6) Separated from vehicle
- (7) Noncontact injury
- (8) Other specify: \_\_\_\_\_
- (9) Unknown

**DAMAGE DEPTH**

- (0) Injury not from vehicle contact
- (1) No residual damage
- (2) Surface only damage
- (3) Crush depth >0 to 2 centimeters
- (4) Crush depth > 2 to 5 centimeters
- (5) Crush depth > 5 to 10 centimeters
- (8) Other specify: \_\_\_\_\_
- (9) Unknown

**PEDESTRIAN INJURY CLASSIFICATION****Body Region**

- (1) Head
- (2) Face
- (3) Neck
- (4) Thorax
- (5) Abdomen
- (6) Spine
- (7) Upper Extremity
- (8) Lower Extremity
- (9) Unspecified

**Type of Anatomic Structure**

- (1) Whole Area
- (2) Vessels
- (3) Nerves
- (4) Organs (includes muscles/ligaments)
- (5) Skeletal (includes joints)
- (6) Head - LOC
- (9) Skin

**Specific Anatomic Structure**Whole Area

- (02) Skin - Abrasion
- (04) Skin - Contusion
- (06) Skin - Laceration
- (08) Skin - Avulsion
- (10) Amputation
- (20) Burn
- (30) Crush
- (40) Degloving
- (50) Injury - NFS
- (90) Trauma, other than mechanical

Head - LOC

- (02) Length of LOC
- (04, 06, 08) Level of Consciousness
- (10) Concussion

Spine

- (02) Cervical
- (04) Thoracic
- (06) Lumbar

Vessels, Nerves, Organs, Bones, Joints are assigned consecutive two digit numbers beginning with 02

Level of Injury

Specific injuries are assigned consecutive two-digit numbers beginning with 02.

To the extent possible, within the organizational framework of the AIS, 00 is assigned to an injury NFS as to severity or where only one injury is given in the dictionary for that anatomic structure. 99 is assigned to any injury NFS as to lesion or severity.

**Abbreviated Injury Scale**

- (1) Minor injury
- (2) Moderate injury
- (3) Serious injury
- (4) Severe injury
- (5) Critical injury
- (6) Maximum (untreatable)
- (7) Injured, unknown severity

**Aspect**

- (1) Right
- (2) Left
- (3) Bilateral
- (4) Central
- (5) Anterior
- (6) Posterior
- (7) Superior
- (8) Inferior
- (9) Unknown
- (0) Whole region

**INJURY SOURCE**FRONT

- 700 Front bumper
- 701 Front lower valance/spoiler
- 702 Front grille
- 703 Hood edge and/or trim
- 704 Hood ornament (fixed)
- 705 Hood ornament (spring loaded)
- 706 Headlight
- 707 Retractable headlight door (Open/Closed)
- 708 Turn signal/parking lights
- 718 Other front or add on object (specify): \_\_\_\_\_
- 719 Unknown front object

Left Side Components

- 720 Front fender side surface
- 721 Front antenna
- 722 A1 pillar
- 723 A2 pillar
- 724 B pillar
- 725 C pillar
- 726 D pillar
- 728 Other pillar (specify): \_\_\_\_\_
- 729 Left side roof rail
- 730 Left side door surface
- 731 Left side door handle
- 732 Left side mirror fixed housing
- 733 Left side folding mirror
- 734 Left side glazing forward of B pillar
- 735 Left side glazing rearward of B pillar
- 736 Left side back fender or quarter panel
- 737 Rear antenna
- 738 Other left side object (specify): \_\_\_\_\_
- 739 Unknown left side component

Right Side Components

- 740 Front fender side surface
- 741 Front antenna
- 742 A1 pillar
- 743 A2 pillar

- 744 B pillar
- 745 C pillar
- 746 D pillar
- 748 Other pillar (specify): \_\_\_\_\_
- 749 Right side roof rail
- 750 Right side door surface
- 751 Right side door handle
- 752 Right side mirror fixed housing
- 753 Right side folding mirror
- 754 Right side glazing forward of B pillar
- 755 Right side glazing rearward of B pillar
- 756 Rear antenna
- 757 Rear fender or quarter panel
- 758 Other right side object (specify): \_\_\_\_\_
- 759 Unknown right side component

Back Components

- 760 Rear (back) bumper
- 761 Tailgate
- 762 Hatchback, vertical surface
- 768 Other back component (specify): \_\_\_\_\_
- 769 Unknown back component

Top Components

- 770 Hood surface
- 771 Hood surface reinforced by under hood component
- 772 Front fender top surface
- 773 Cowl area
- 774 Wiper blade & mountings
- 775 Windshield glazing
- 776 Front header
- 777 Roof surface
- 778 Backlight glazing
- 779 Rear header
- 780 Hatchback
- 781 Rear trunk lid
- 788 Other top component (specify): \_\_\_\_\_
- 789 Unknown top component

Wheels / tires

- 790 Left front wheel / tire
- 791 Right front wheel / tire
- 792 Left rear wheel / tire
- 793 Right rear wheel / tire
- 798 Other wheel / tire (specify): \_\_\_\_\_
- 799 Unknown wheel / tire

Undercarriage components

- 800 Front crossmember
- 801 Steering assembly/Front suspension
- 802 Oil pan
- 803 Exhaust system pipe
- 804 Transmission
- 805 Drive shaft
- 806 Catalytic converter
- 807 Muffler
- 808 Floor pan
- 809 Fuel tank
- 810 Rear suspension
- 818 Other undercarriage component (specify): \_\_\_\_\_
- 819 Unknown undercarriage component

Accessories

- 820 Air scoop, deflector
- 821 Cellular or CB radio antenna
- 822 Emergency lights or bar
- 823 Fog lights
- 824 Luggage, ski, or bike rack
- 825 Cargo (specify): \_\_\_\_\_
- 826 Spare tire
- 827 Spotlight
- 828 Other accessory (specify): \_\_\_\_\_

Other Object or Vehicle in Environment

- 947 Ground
- 948 Other object (specify): \_\_\_\_\_
- 949 Unknown object in environment
- 959 Unknown object on contacting vehicle
- 997 Noncontact injury source
- 999 Unknown injury source

# OFFICIAL INJURY DATA — SKELETAL INJURIES

BEST AVAILABLE

Restrained?

No

Yes

Indicate the Location, Specific Anatomic Structure, Detail (size, depth, fracture type, head injury clinical signs and neurological deficits), and Source of all injuries indicated by official sources (or from PAR or other unofficial sources if medical records and interviewee data are unavailable.)

Blood Alcohol Level  
(mg/dl)

BAL = \_\_\_\_

Glasgow Coma  
Scale Score

GCSS = \_\_\_\_

Units of Blood  
Given

Units = \_\_\_\_

Arterial Blood Gases

Ph = \_\_\_\_

PO<sub>2</sub> = \_\_\_\_

PCO<sub>2</sub> = \_\_\_\_

HCO<sub>3</sub> = \_\_\_\_

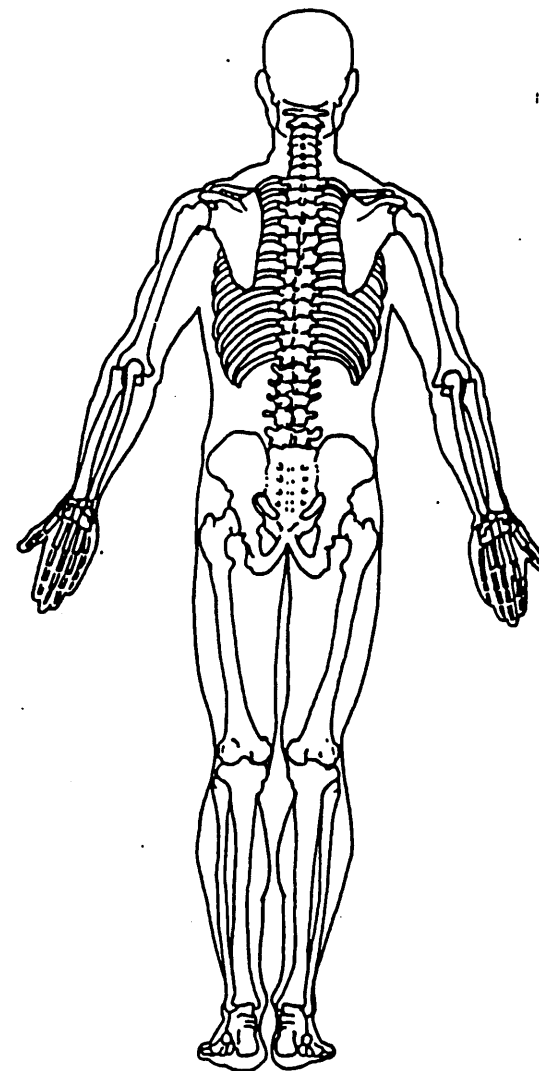
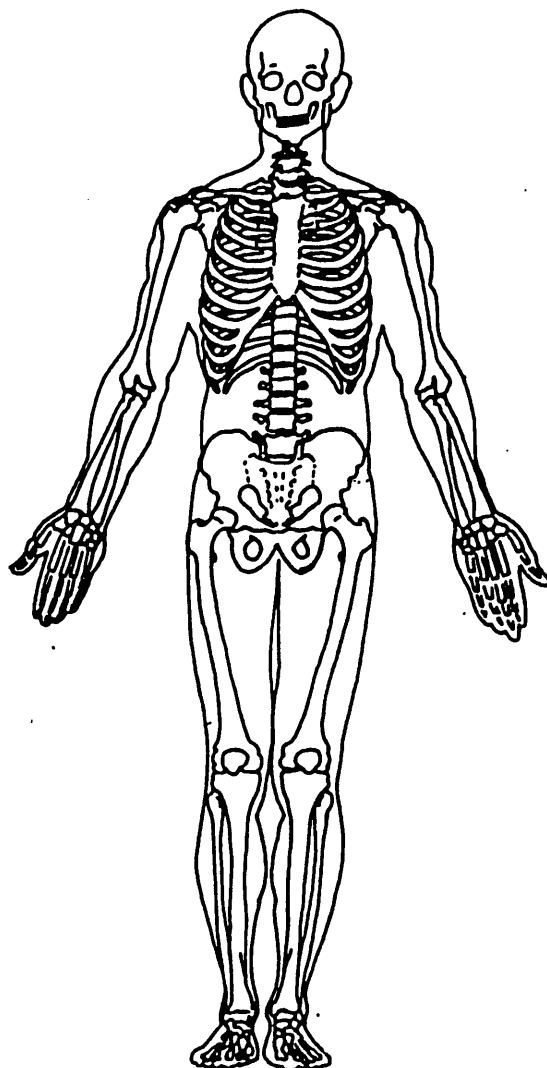



## OFFICIAL INJURY DATA — INTERNAL INJURIES

BEST AVAILABLE

Indicate the Location, Specific Anatomic Structure, Detail (size, depth, fracture type, head injury clinical signs and neurological deficits), and Source of all injuries indicated by official sources (or from PAR or other unofficial sources if medical records and interviewee data are unavailable.)

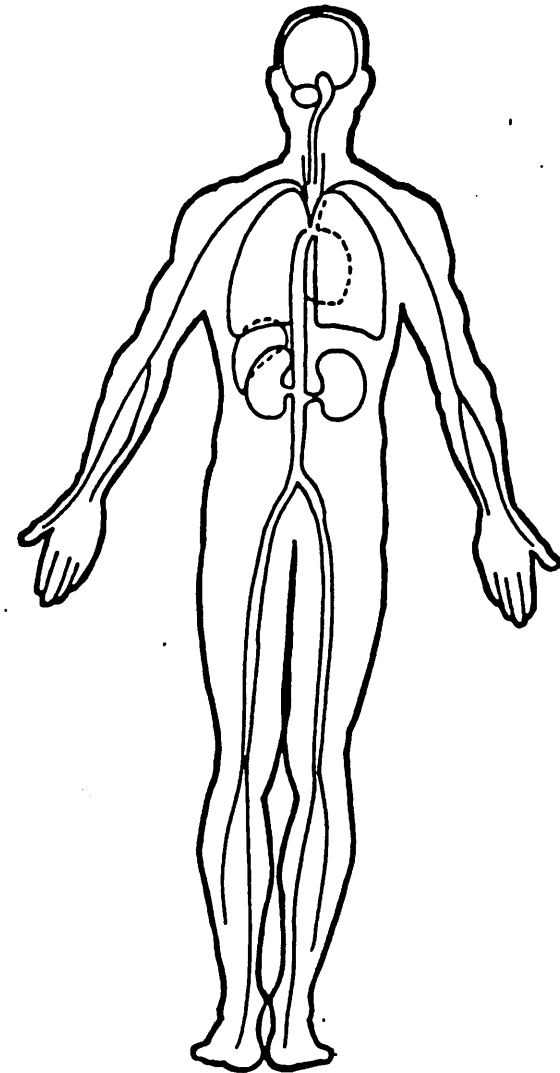
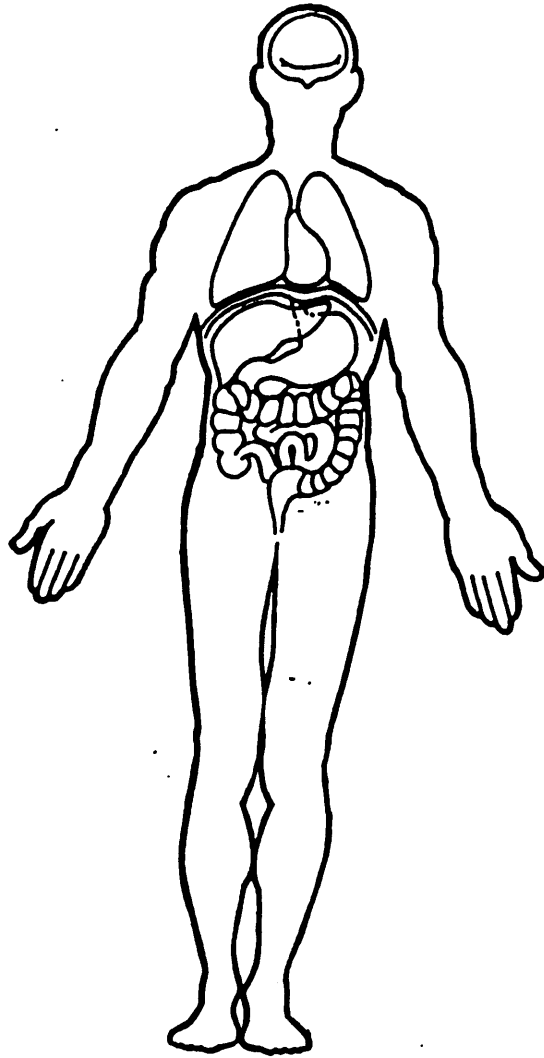

1  
PSU40  
CASE 609P

1998 PEDESTRIAN ACCIDENT FORM

IDENTIFICATION

3. Number of General Vehicle Forms Submitted 01  
4. Date of Accident (Month, Day, Year) 98  
5. Time of Accident (military time) 0855

SPECIAL STUDIES - INDICATORS

6. SS15 0      7. SS16 1      8. SS17 0      9. SS18 0      10. SS19 0

NUMBER OF EVENTS

11. Number of Recorded Events in This Accident 01  
01

PSU40  
CASE 609P

1998 PEDESTRIAN ACCIDENT FORM

PEDESTRIAN ACCIDENT EVENTS

Accident Sequence Number	Vehicle Number	Class of Vehicle	General Area of Damage	Veh. Num. or Obj. Cont.	Class of Vehicle	General Area of Damage
-----	-----	-----	-----	-----	-----	-----
12. 01	13. 01	14. 02	15. F	16. 72	17. 00	18. 0

01

PSU40  
CASE 609P  
VEHICLE 01 PEDESTRIAN 01

1998 PEDESTRIAN ASSESSMENT FORM

PEDESTRIAN'S CHARACTERISTICS

4. Pedestrian's Age	03
5. Pedestrian's Sex	1
6. Pedestrian's Overall Height	103
7. Pedestrian's Height - Ground to Knee	27
8. Pedestrian's Height - Ground to Hip	050
9. Pedestrian's Height - Ground to Shoulder	078
10. Pedestrian's Weight	020

PEDESTRIAN'S PRE-AVOIDANCE ACTIONS

11. Pedestrian's Attitude	1
12. Pedestrian's Motion	1
13. Pedestrian's Actions Relative to Vehicle	01
14. Pedestrian's Body (Chest) Orientation Relative to Striking Vehicle Prior to Avoidance Actions	3

PEDESTRIAN'S AVOIDANCE ACTIONS

15. Pedestrian's First Avoidance Actions	00
--	----

PEDESTRIAN'S ORIENTATION AT IMPACT

16. Pedestrian's Head Orientation at Initial Impact	1
17. Pedestrian's Body (Chest) Orientation at Initial Impact	3
18. Pedestrian's Arm Orientation at Initial Impact	01
19. Pedestrian's Leg Orientation at Initial Impact	99
20. Vehicle/Pedestrian's Interaction	08

OFFICIAL RECORDS

21. Police Reported Alcohol Presence For Pedestrian	7
22. Alcohol Test Result For Pedestrian	96
23. Police Reported Other Drug Presence For Pedestrian	0
24. Other Drug Specimen Test Result For Pedestrian	0

INJURY CONSEQUENCES

25. Injury Severity (Police Rating)	1
26. Treatment - Mortality	4
27. Type of Medical Facility (for Initial Treatment)	2
28. Hospital Stay	00
29. Working Days Lost	97

(COMPLETED BY THE ZONE CENTER)

30. Glasgow Coma Scale Score	15
31. Was the Pedestrian Given Blood?	1
32. Arterial Blood Gases	01
33. Time to Death	00
34. 1st Medically Reported Cause of Death	00
35. 2nd Medically Reported Cause of Death	00
36. 3rd Medically Reported Cause of Death	00
37. Number of Recorded Injuries for This Pedestrian	04

01

PSU40  
CASE 609P  
VEHICLE 01 PEDESTRIAN 01

1998 PEDESTRIAN INJURY FORM

PEDESTRIAN INJURY DATA

	Source of Inj. Data	Body Reg.	Type of Anat. Struc.	Spec. Anat. Struc.	Lev. of Inj.	AIS Sev.	Asp.	Inj. Source	Inj. Conf. Level	Dir./ Indir. Inj.	Str. Pro.	Type of Dmg.	Dmg. Dep.
01.	3	2	9	72	02	1	2	703	1	1	3	2	2
02.	3	2	9	02	02	1	7	703	1	1	3	2	2
03.	3	1	9	02	02	1	2	703	1	1	3	2	2
04.	3	2	9	04	02	1	9	703	1	1	3	2	2

01  
PSU40  
CASE 609P  
VEHICLE 01

1998 PEDESTRIAN GENERAL VEHICLE FORM

VEHICLE IDENTIFICATION

4. Vehicle Model Year 96  
5. Vehicle Make 24  
6. Vehicle Model 003  
7. Body Type 04  
8. Vehicle Identification Number 1G8ZK5271TZ

OFFICIAL RECORDS

9. Police Reported Travel Speed 999  
10. Speed Limit 999  
11. Police Reported Alcohol Presence For Driver 7  
12. Alcohol Test Result For Driver 96  
13. Police Reported Other Drug Presence 0  
14. Other Drug Specimen Test Result for Driver 0

VEHICLE WEIGHT ITEMS

15. Vehicle Curb Weight 1,090  
16. Vehicle Cargo Weight 9,990

OTHER DATA

17. Vehicle Special Use (This Trip) 0

RECONSTRUCTION DATA (COMPLETED BY THE ZONE CENTER)

18. Impact Speed +999  
19. Accuracy Range of Impact Speed Estimate 9  
20. Data Source of Impact Speed 0

PRECRASH DATA

21. Driver's Attention to Driving 4  
22. Pre-Event Vehicle Movement 10



FRONT CONTACT DAMAGE

FRONT VERTICAL MEASUREMENTS

14. Front Bumper Cover Material	1	15. Front Bumper Reinforcement Mat.	1
16. Front Bumper-Bottom Height	038	17. Front Bumper-Top Height	050
18. Forward Hood Opening	062	19. Front Bumper Lead	10

FRONT WRAP DISTANCE MEASUREMENTS

20. Ground to Fwd. Hood Opening	068	21. Ground to Front/Top Transition Pt	087
22. Ground to Rear Hood Opening	168	23. Ground to Base of Windshield	179
24. Ground to Top of Windshield	265	25. Ground to Head Contact	998

SIDE CONTACT DAMAGE

SIDE VERTICAL MEASUREMENTS

26. Ground Clearance	000
27. Side Bumper-Bottom Height	000
28. Side Bumper-Top Height	000
29. Centerline of Wheel	000
30. Top of Tire	000
31. Top of Wheel Well Opening	000
32. Bottom of A-Pillar at Windshield	000
33. Top of A-Pillar at Windshield	000
34. Top of Side View Mirror	000

SIDE CONTACT DAMAGE (continued)

SIDE LATERAL MEASUREMENTS

35. Centerline to A-Pillar at Bottom of Windshield	000
36. Centerline to A-Pillar at Top of Windshield	000
37. Centerline to Maximum Side View Mirror Protrusion	000

SIDE WRAP DISTANCE MEASUREMENTS

38. Ground to Side/Top Transition	000
39. Ground to Hood Edge	000
40. Ground to Centerline of Hood (Origin)	000
41. Ground to Head Contact	000

0





PSU40  
CASE 609P  
CURRENT VERSION: 11.0

ERROR SUMMARY SCREEN  
PEDESTRIAN STUDY

99

FORM NAME	NUMBER OF DOLLAR SIGNS	NUMBER OF LEVEL 1 ERRORS	NUMBER OF LEVEL 2 ERRORS	VERSION NUMBER CONSISTENT
Pedestrian Accident	0	0	0	Y
Pedestrian Assessment	0	0	0	Y
Pedestrian Injury	0	0	0	Y
Pedestrian General Vehicle	0	0	0	Y
Pedestrian Exterior Vehicle	0	0	0	Y
Total Inter Errors		0	0	
Total Case Errors	0	0	0	